

English

Operating manual

Recirculating coolers

FC600	FC600S	FCW600	FCW600S
FC1200	FC1200S	FCW1200	FCW1200S
FC1600	FC1600S	FCW1600	FCW1600S

air-cooled

water cooled

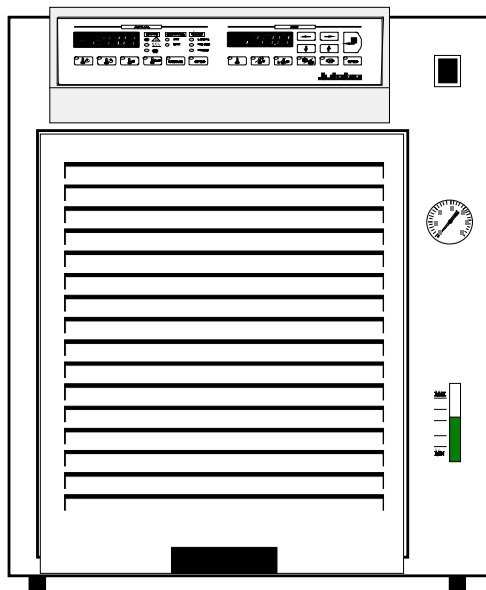

Julabo
THE TEMPERATURE CONTROL COMPANY

JULABO USA, Inc.
884 Marcon Boulevard
Allentown, PA 18109
Phone: +1(610) 231-0250
Fax: +1(610) 231-0260
info@julabo.us
www.julabo.us

Congratulations!

You have made an excellent choice.

JULABO thanks you for the trust you have placed in us.

This operating manual has been designed to help you gain an understanding of the operation and possible applications of our circulators. For optimal utilization of all functions, we recommend that you thoroughly study this manual prior to beginning operation.

The JULABO Quality Management System



Temperature control devices for research and industry are developed, produced, and distributed according to the requirements of ISO 9001 and ISO 14001. Certificate Registration No. 01 100044846

Unpacking and inspecting

Unpack the recirculating cooler and accessories and check for damages incurred during transit. These should be reported to the responsible carrier, railway, or postal authority, and a request for a damage report should be made. These instructions must be followed fully for us to guarantee our full support of your claim for protecting against loss from concealed damage. The form required for filing such a claim will be provided by the carrier.

Important: keep operating manual for future use

Table of Contents

1.	Intended use.....	4
1.1.	Description.....	4
2.	Operator responsibility – Safety instructions.....	4
2.1.	Disposal.....	6
2.2.	Technical specifications.....	7
2.3.	Cooling water connection.....	10
3.	Safety notes for the user.....	11
3.1.	Explanation of safety notes.....	11
3.2.	Explanation of other notes.....	11
3.3.	Safety instructions.....	11
4.	Operating controls and functional elements.....	13
5.	Operation.....	16
5.1.	Preparations.....	16
5.2.	Return flow safety device.....	17
5.3.	Bath fluids.....	18
5.4.	Tubing.....	18
5.5.	Power connection.....	19
5.6.	Filling.....	19
5.7.	Draining.....	20
6.	Manual operation.....	21
6.1.	Switching on.....	21
6.2.	Start.....	21
6.2.1.	Automatic / non-automatic start mode.....	22
6.3.	Setting the setpoint temperatures.....	23
6.3.1.	Setting the temperature.....	23
6.3.2.	Setting the control ratio for feed/return flow temperature.....	24
6.3.3.	Setting the safety temperatures.....	25
6.3.4.	Low liquid level protection.....	25
6.4.	PID control parameters.....	26
7.	Trouble shooting guide.....	28
7.1.	Other error messages.....	29
8.	Electrical connections.....	29
9.	Remote control.....	31
9.1.	Communication with a PC or data system.....	31
9.2.	List of commands.....	32
9.3.	Status messages.....	33
9.4.	Error messages.....	33
10.	Menu functions.....	34
10.1.	Selecting/exiting the configuration level.....	34
10.2.	Setting the parameters.....	34
10.3.	Adjustable parameters.....	35
11.	Cleaning / repairing the unit.....	36
12.	WARRANTY PROVISIONS.....	37

1. Intended use

JULABO recirculating coolers have been designed for temperature application to specific fluids. The pump connections can be used for cooling applications in an external circuit at a constant temperature.



JULABO recirculating coolers are not suitable for direct temperature control of foods, semi-luxury foods and tobacco, or pharmaceutical and medical products. Direct temperature control means unprotected contact of the object with the bath medium (bath fluid).

1.1. Description

The recirculating cooler consists of

- control unit with splash-proof keypad (microprocessor technology)
- cooling compressor
- heater
- heating/cooling bath and recirculating pump

The electronics comprises two microprocessors that provide reciprocal monitoring via sensors for the working and safety circuit.

The actual and setpoint temperatures are permanently visible on the MULTI-DISPLAY (LED 1 + LED 2) and thus may be easily compared.

The bath tank is located in the lower part of the unit. The cooling machine draws heat from the bath liquid via the cooling coil (evaporator). If the setpoint lies above the ambient temperature, the integrated heater produces more heat.

The integrated circulating pump ensures constant conditions for the external cooling loop and provides a good circulation of the liquid in the bath tank.

The unit provides analog electrical connections and a serial interface.

Safety installations: High temperature and low temperature limits, both adjustable via the MULTI-DISPLAY, as well as low liquid level protection.

2. Operator responsibility – Safety instructions

The products of JULABO ensure safe operation when installed, operated, and maintained according to common safety regulations. This section explains the potential dangers that may arise when operating the recirculating coolers and also specifies the most important safety precautions to preclude these dangers as far as possible.

The operator is responsible for the qualification of the personnel operating the units.

- The personnel operating the units should be regularly instructed about the dangers involved with their job activities as well as measures to avert these dangers.
- Make sure all persons tasked with operating, installing, and maintaining the unit have read and understand the safety information and operating instructions.
- When using hazardous materials or materials that could become hazardous, the unit may be operated only by persons who are absolutely familiar with these materials and the unit. These persons must be fully aware of possible risks.

If you have any questions concerning the operation of your unit or the information in this manual, please contact us!

Contact	JULABO USA, Inc. 884 Marcon Boulevard Allentown, PA 18109	Phone: +1(610) 231-0250 Fax: +1(610) 231-0260 info@julabo.us www.julabo.us
----------------	---	---

Safety recommendations for the operator

- You received a product conceived for industrial use. Nevertheless, avoid strikes to the housing, vibrations, damages to the keypad foil (keys, display) or contamination.
- Make sure the product is regularly checked for proper condition. Regularly check (at least every 2 years) the proper condition of the mandatory, warning, prohibition and safety labels.
- Take care that the mains supply features a low impedance to avoid any negative affects on the instrument being operated in the same mains.
- This unit is designed for operation in a controlled electromagnetic environment. This means that transmitting devices (e.g. cellular phones) should not be used in the immediate vicinity. Magnetic radiation may influence other units with components susceptible to magnetic fields (e.g. a monitor). We recommend to keep a minimum distance of 1 m.
- Permissible ambient temperature: max. 40 °C, min. 5 °C.
- Permissible relative air humidity: 50 % (40 °C).
- Do not store in an aggressive atmosphere. Protect from contaminations.
- Do not expose to sunlight.

Appropriate Operation

Only qualified personnel is authorized to perform configuration, installation, maintenance and repairs of the water bath.

Routine operation can also be carried out by untrained personnel who should however be instructed by trained personnel.

Operator responsibility – Safety instructions



Use

For the use according to the intended purpose, special material requirements have to be respected (bath fluids). Only use non-acid and non corroding materials.

Observe all warnings for the used materials (bath fluids) and the respective instructions (safety data sheets).

Only use the unit in well ventilated areas. The recirculating coolers are not for use in explosive atmosphere

When using hazardous materials or materials that could become hazardous, the operator must affix the enclosed safety labels (1 + 2) to the front of the unit so they are highly visible:

1		Danger area. Attention! Observe instructions. (operating manual, safety data sheet)
2		Carefully read the user information prior to beginning operation. Scope: EU
or		
2		Carefully read the user information prior to beginning operation. Scope: USA, NAFTA

Observe the instructions in the manuals for instruments of a different make that you connect to the recirculating cooler, particularly the corresponding safety instructions. Also observe the pin assignment of plugs and technical specifications of the products.

2.1. Disposal

This unit contains the refrigerants R134a or R404A, which at this time are not considered harmful to the ozone layer. However, over the long operating period of the unit, disposal rules may change. Therefore, only qualified personnel should handle the disposal.

2.2. Technical specifications

Performance specifications measured in accordance with DIN12876. Cooling capacities up to 20°C measured with ethanol; over 20°C with thermal oil unless specified otherwise. Performance specifications apply at an ambient temperature of 20°C. Performance values may differ with other bath fluids.

		FC(W)600	FC(W)600S
Working temperature range	°C	-20 ... 80	-10 ... 80
Cooling capacity	°C	20 5 -10	20 5 -10
(water-glycol)	kW	0.6 0.4 0.21	0.5 0.3 0.1
Refrigerant		R134a	R134a
Heater capacity	kW	1.2	1.2
Pump capacity:			
Pressure max.	psi	7.25	17.4
Flow rate max.	lpm	20 / 14	22 / 15
with tubing connections	mm Ø	13.5 / 9.5	13.5 / 9.5
Pump connections		M16x1	M16x1
Noise level, 1 m distance	dBA	51	54
Filling volume	l	6 ... 8	6 ... 8
Dimensions (WxLxH)	mm	350 x 540 x 490	350 x 540 x 490
Shipping weight	Kg	48	52
Mains power connection	V/Hz	230 / 50/60	230 / 50/60
Current consumption	A	7	8

		FC(W)1200	FC(W)1200S
Working temperature range	°C	-20 ... 80	-15 ... 80
Cooling capacity	°C	20 5 -10	20 5 -10
(water-glycol)	kW	1.3 0.75 0.37	1.2 0.65 0.26
Refrigerant		R134a	R134a
Heater capacity	kW	1.2	1,2
Pump capacity:			
Pressure max.	psi	7.25	17.4
Flow rate max.	lpm	20 / 14	22 / 15
with tubing connections	mm Ø	13.5 / 9.5	13.5 / 9.5
Pump connections		M16x1	M16x1
Noise level, 1 m distance	dBA	53	57
Filling volume	l	8 ... 11	8 ... 11
Dimensions (WxLxH)	mm	460 x 610 x 490	460 x 610 x 490
Shipping weight	Kg	60	66
Mains power connection	V/Hz	230 / 50	230 / 50
Current consumption	A	7	8

Operator responsibility – Safety instructions

		FC(W)1600	FC(W)1600S
Working temperature range	°C	-20 ... 80	-15 ... 80
Cooling capacity	°C	20 5 -10	20 5 -10
(water-glycol)	kW	1.65 1.0 0.47	1.55 0.9 0.36
Refrigerant		R134a	R134a
Heater capacity	kW	1,2	1,2
Pump capacity:			
Pressure max.	bar	0.5	1.2
Flow rate max.	l/min	20 / 14	22 / 15
with tubing connections	mm Ø	13,5 / 9,5	13,5 / 9,5
Pump connections		M16x1	M16x1
Noise level, 1 m distance	dBA	53	57
Filling volume	l	8 ... 11	8 ... 11
Dimensions (WxLxH)	mm	460 x 610 x 490	460 x 610 x 490
Shipping weight	Kg	65	66
Mains power connection	V/Hz	230 / 50/60	230 / 50/60
Current consumption	A	7	8

Temperature selection		digital (keypad)
Resolution	°C	0.1
MULTI-DISPLAY indications		LED + LED
Resolution	°C	0.1
Display accuracy	%	0.5
Temperature stability	°C	±0.2
Temperature control		on/off
Control ratio for feed/return		
flow temperature, adjustable	%	0 ... 100
Temperature sensor (number)		PTC (3)
Level indication		spy-glass
Error message indication		LED
<u>Electrical connections:</u>		
Computer interface		RS 232
Stand-by input		conforming to Namur recommendations
Alarm output		potential-free
Return flow safety device	V	230

Safety installations

(adjustable via LED):

High temperature protection	°C	-25 ... 85
Low temperature protection	°C	-25 ... 85
Low liquid level protection		float switch
Classification according to DIN 12876-1		III
Overload protection for pump motor		contactor
Overload protection for cooling compressor		contactor
Alarm signal		optical + audible

Environmental conditions according to IEC 61 010-1:

Use only indoor.

Altitude up to 2000 m - normal zero.

Ambient temperature: +5 ... +40 °C

Air humidity:

Max. rel. humidity 80 % for temperatures up to +31 °C,

linear decrease down to 50 % relative humidity at a temperature of +40 °C

Max. mains fluctuations of ±10 % are permissible.

IP class according to IEC 60 529	IP21
The unit corresponds to Class	I
Overvoltage category	II
Pollution degree	2



Caution:

The unit is not for use in explosive environment.

EMC requirements

The device is an ISM device of group 1 per CISPR 11 (uses HF for internal purposes) and is classified in class A (industrial and commercial sector).

NOTICE:

- Devices of class A are intended for the use in an industrial electromagnetic environment.
- When operating in other electromagnetic environments, their electromagnetic compatibility may be impacted.

2.3. Cooling water connection

Only for water cooled models - FCW:

Cooling water pressure (IN / OUT)	max.	6 bar
Difference pressure (IN - OUT)		3.5 to 6 bar
Cooling water temperature		<20 °C

Recommended quality of cooling water:

pH – value	7,5 to 9,0
Sulfate [SO ₄ 2-]	< 100 ppm
Hydrocarbonate [HCO ₃ -] / Sulphate [SO ₄ 2-]	> 1 ppm
Hardness [Ca ²⁺ , Mg ²⁺] / [HCO ₃ -]	> 0,5 dH
Alkalinity	60 ppm < [HCO ₃ -] < 300 ppm
Conductivity	< 500 µs / cm
Chloride (CL-)	< 50 ppm
Phosphate (PO ₄ 3-)	< 2 ppm
Ammonia (NH ₃)	< 0,5 ppm
Free Chlorine	< 0,5 ppm
Ferri Ions (Fe ³⁺)	< 0,5 ppm
Mangano Ions (Mn ²⁺)	< 0,05 ppm
Carbon dioxide (CO ₂)	< 10 ppm
Hydrosulfide (H ₂ S)	< 50 ppm
Content of oxygen	< 0,1 ppm
Algae growth	impermissible
Suspended solids	impermissible



Notice:

Danger of corrosion of heat exchanger due to unsuitable quality of cooling water.

- Due to its high content of lime hart water is not suitable for cooling and causes calcination of the heat exchanger.
- Ferrous water or water containing ferrous particles will cause formation of rust even in heat exchangers made of stainless steel.
- Chlorous water will cause pitting corrosion in heat exchangers made of stainless steel.
- Due to its corrosive characteristics distilled and deionized water is unsuitable and will cause corrosion of the bath. .
- Due to its corrosive characteristics sea water is not suitable.
- Due to its microbiological (bacteria) components which settle in the heat exchanger untreated and unpurified river water and water from cooling towers is unsuitable.
- Avoid particulate matter in cooling water.
- Avoid putrid water.

3. Safety notes for the user

3.1. Explanation of safety notes



In addition to the safety warnings listed above, warnings are posted throughout the manual. These warnings are designated by an exclamation mark inside an equilateral triangle. "Warning of a dangerous situation (Attention! Please follow the documentation)."

The danger is classified using a signal word.
Read and follow these important instructions.



Warning:

Describes a possibly highly dangerous situation. If these instructions are not followed, serious injury and danger to life could result.



Caution:

Describes a possibly dangerous situation. If this is not avoided, slight or minor injuries could result. A warning of possible property damage may also be contained in the text.



Notice:

Describes a possibly harmful situation. If this is not avoided, the product or anything in its surroundings can be damaged.

3.2. Explanation of other notes



Note!

Draws attention to something special.



Important!

Indicates usage tips and other useful information.

3.3. Safety instructions

Follow the safety recommendations to prevent damage to persons or property. Further, the valid safety instructions for working places must be followed.



- Only connect the unit to a power socket with earthing contact (PE – protective earth)!
- The power supply plug serves as a safe disconnecting device from the line and must always be easily accessible.
- Place the instrument on an even surface on a pad made of non-flammable material.
- Never operate the unit without bath fluid in the bath.
- Do not stay in the area below the unit.
- Make sure you read and understand all instructions and safety

Safety notes for the user

precautions listed in this manual before installing or operating your unit.

- Never operate the unit without bath fluid in the bath.
- Do not drain the bath fluid while it is hot or cold!
Check the temperature of the bath fluid prior to draining (by switching the unit on for a short moment for example).
- Use suitable connecting tubing.
- Avoid sharp bends in the tubing, and maintain a sufficient distance from surrounding walls.
- Make sure that the tubing is securely attached.
- Regularly check the tubing for material defects (e.g., for cracks).
- Never operate damaged or leaking equipment.
- Always turn off the unit and disconnect the mains cable from the power source before performing any service or maintenance procedures, or before moving the unit.
- Always turn off the unit and disconnect the mains cable from the power source before cleaning the unit.
- Always empty the bath before moving the unit.
- Transport the unit with care.
- Sudden jolts or drops may cause damage in the interior of the unit.
- Observe all warning labels.
- Never remove warning labels.
- Never operate equipment with damaged mains power cables.
- Repairs are to be carried out only by qualified service personnel.



WARNING

This product contains chemicals known to the state of California to cause cancer, birth defects or other reproductive harm.

4. Operating controls and functional elements

1. Mains power switch, illuminated

- 7. Filling funnel
- 8. Drain tubing
- 9. Drain tap
- 10. Filling level indication
- 11. Pump pressure gauge

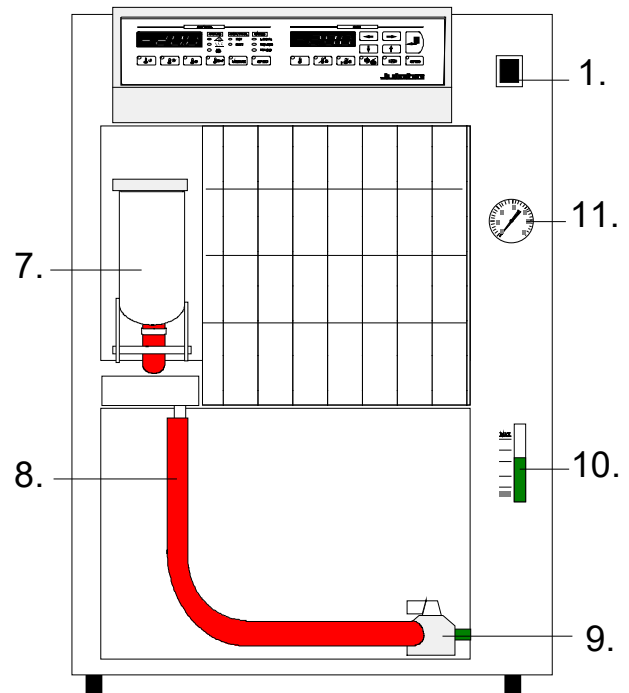

2. MULTI-Display temperature indication  (LED 1 + LED 2)

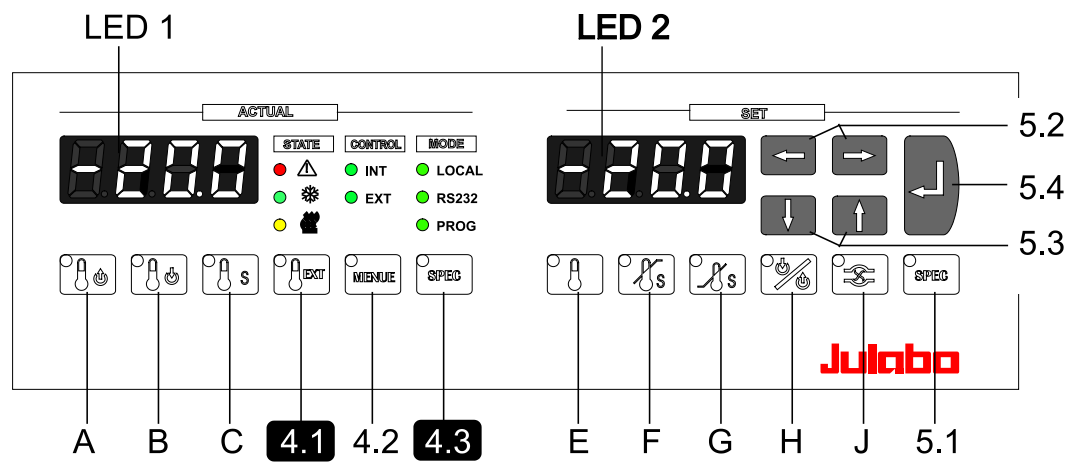





3. Indicator lights



STATE	CONTROL	MODE
Alarm	INT Temp.	LOCAL = Keypad control mode
Heating	EXT Control	RS 232 = Remote control mode
Cooling		PROG

Operating controls and functional elements





4. Keys for actual values ACTUAL (LED 1)

- A  Key - Indication of feed temperature
- B  Key - Indication of return temperature
- C  Key - Indication of safety temperature

4.2  The "MENU" key is not required for normal operating

- 4.1**  The keys "EXT" and "SPEC" are not required for
- 4.3**  this model version.



5. Keys for setpoint values SET (LED 2)

- E  Key - Indication or setting of working temperature
- F  Key - Indication or setting of high temperature
- G  Key - Indication or setting of low temperature
- H  Key - Indication or setting of control ratio for feed/return
flow temperature

J  Key - Circulating pump On/Off

5.1  Key - "SPEC" - PID control parameters

5.2   Cursors left/right

5.3   Edit keys (increase/decrease setting)

5.4  Enter key (start, store)

6. Electrical connectors

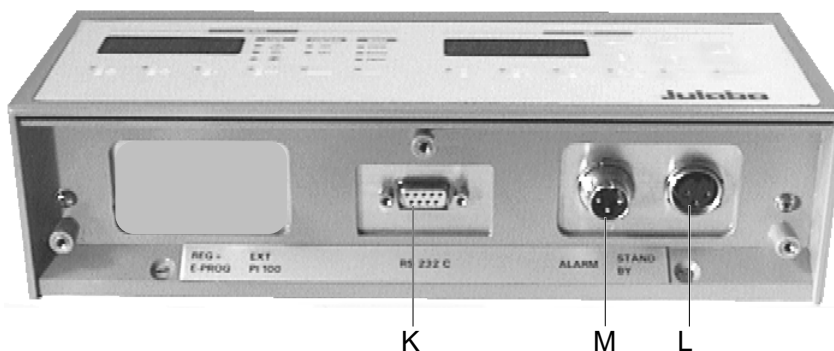

K Interface RS 232

M Alarm output (for external alarm signal)

L Stand-by input conforming to NAMUR recommendations
(external emergency switch-off)

Rear

- 12.1 Pump connector: Feed
- 12.2 Pump connector: Return
- 13. Overflow port for bath tank
- 14. Connectors for solenoid valves
- 15. Mains power cable with plug

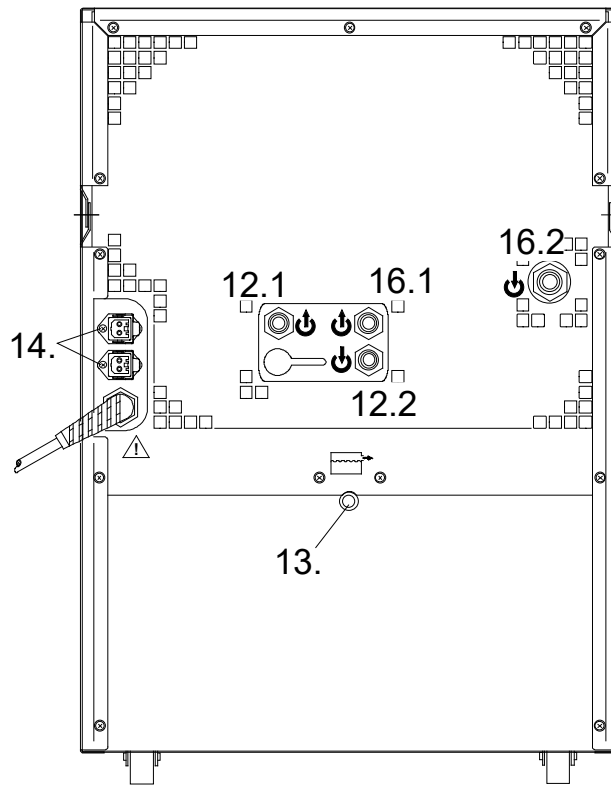

Only for water cooled models:

- 16.1 Cooling water OUTLET
- 16.2 Cooling water INLET

5. Operation

5.1. Preparations

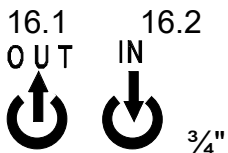
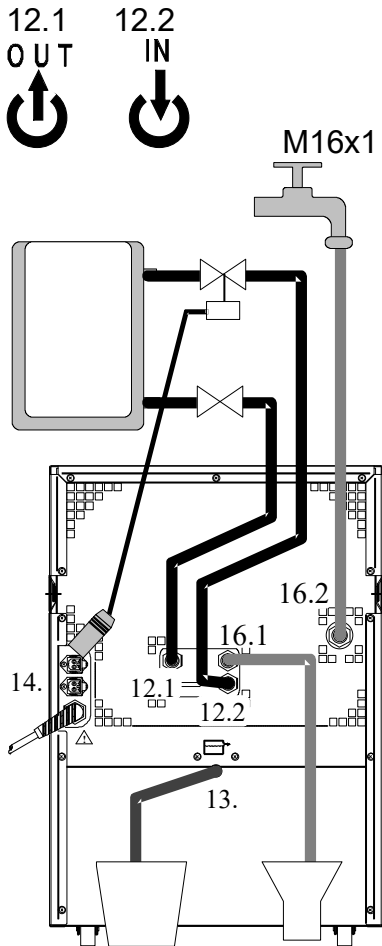

- Place the unit in an upright position.
- The place of installation should be large enough and provide sufficient air ventilation to ensure the room does not warm up excessively because of the heat the instrument rejects to the environment. (Max. permissible ambient temperature: 40 °C).
For a fault (leakage) in the refrigeration system, the standard EN 378 prescribes a certain room space to be available for each kg of refrigerant.
> For 0.25 kg of refrigerant R134a, 1 m³ of space is required.
- Keep at least 20 cm of open space on the front and rear venting grids.
- Do not set up the unit in the immediate vicinity of heat sources and do not expose to sun light.
- Before operating the unit after transport, **wait about one hour after setting it up**. This will allow any oil that has accumulated laterally during transport to flow back down thus ensuring maximum cooling performance of the compressor.
- Connect the tubings for cooling the external system to the pump connectors for feed and return (12.1. and 12.2.) on the rear of the recirculating cooler.
Return flow safety device see page 17
- If necessary, connect a tube to the overflow port (13.) for controlled draining of the liquid.
Do not close the overflow port.
- **Only for water cooled models:**
Ensure circulation of cooling water by connecting the tubing to cooling water inlet (16.2.) and outlet (16.1) on the rear of the recirculating cooler.
Cooling water temperature: <20 °C
Quality of cooling water see page 10.



Caution:

Securely attach all tubing to prevent slipping.



Notice: Cooling water circuit

Risk of oil leaking from the cooling circuit (compressor) of the recirculating cooler into the cooling water in case of a fault in the circuit!

Observe the laws and regulations of the water distribution company valid in the location where the unit is operated.

5.2. Return flow safety device



Notice: Flood hazard!

In case the system to be cooled is located at a higher level than the recirculating cooler, take note of bath liquid flowing back when the unit is switched off.

Return flow safety device

Should the filling volume of the bath tank not be sufficient, prevent the liquid from flowing back by using shut-off valves..

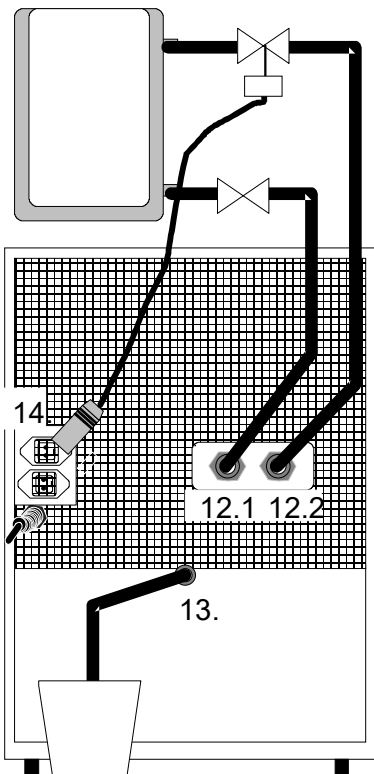

In case the system to be cooled is located at a higher level than the recirculating cooler, prevent the bath liquid from flowing back when the unit is turned off.

For this purpose, connect electrical solenoid valves or mechanical shut-off valves to the connectors for feed and return (12.1. and 12.2.).

The solenoid valve is electrically connected to the connectors (14.). As soon as the recirculating cooler is switched off, the valves close automatically. (Filling - see page 19)

Order No. 8 980 701 Set of solenoid valve (230 V)



5.3. Bath fluids



Caution:

No liability for use of other bath liquids!
 Please contact JULABO before using other than recommended bath fluids.
 JULABO takes no responsibility for damages caused by the selection of an unsuitable bath fluid
Do not use alcohols.

Water:

The quality of water depends on local conditions.

- Due to the high concentration of lime, hard water is not suitable for temperature control because it leads to calcification in the bath.
- Ferrous water can cause corrosion - even on stainless steel.
- Chloric water can cause pitting corrosion.
- Distilled and deionized water is unsuitable. Their special properties cause corrosion in the bath, even in stainless steel.

Water: - No liability for use with water.
 Danger of freezing at working temperatures <5 °C.

Recommended bath fluids:

Bath fluids	Temperature range
soft/decalcified water	5 °C to 80 °C



See website for list of recommended bath fluids.

5.4. Tubing



Caution:

- Employ suitable connecting tubing.
- Make sure that the tubing is securely attached.
- Avoid sharp bends in the tubing, and maintain a sufficient distance from surrounding walls.
- Regularly check the tubing for material defects (e.g. for cracks).
- Preventive maintenance: Replace the tubing from time to time.

	Maximum pressure
Chloroprene tubing	0.5 bar
Textile reinforced tubing	4.5 bar

5.5. Power connection



Caution:

- Only connect the unit to a power socket with earthing contact (PE – protective earth)!
We disclaim all liability for damage caused by incorrect line voltages!
- The power supply plug serves as safe disconnecting device from the line and must be always easily accessible.
- Never operate equipment with damaged mains power cables.
- Regularly check the mains power cables for material defects (e.g. for cracks).

Make sure that the line voltage and frequency match the supply voltage specified on the type plate.

5.6. Filling

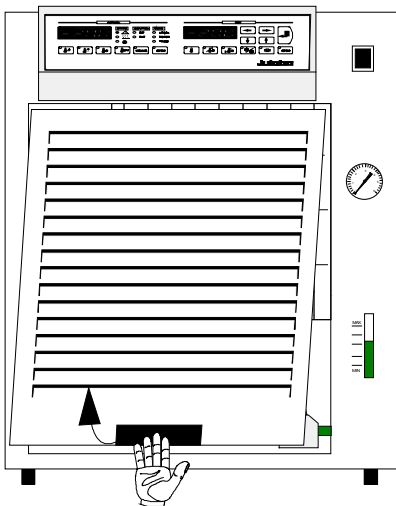

- Connect the tubing from the external system to the pump connectors and check for leaks.
- Hold the venting grid, pull out and remove.
- Check to make sure that the drain tap (9.) is closed.
- Move the filling funnel (7.) to the front and remove cap.
- Fill the bath tank and take care of the filling level (10.).

Activating the circulating pump with simultaneous filling of the external system.

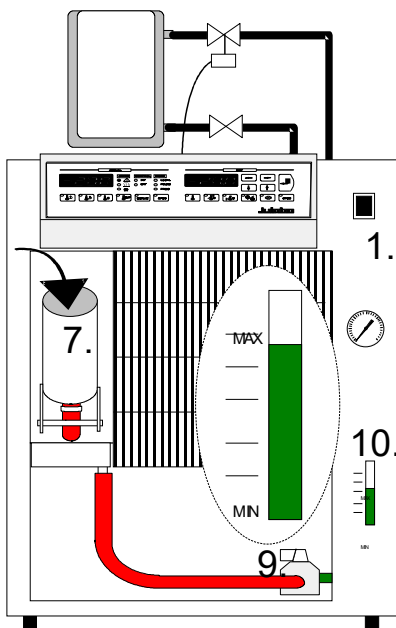

- Turn the mains switch (1.) on (Switching on - see page 21).
- Press the key "J"  to activate the pump for filling the cooling loop for the external system. In case return flow safety devices (Set of solenoid valve) are connected to the connectors (14.) those will simultaneously be opened.
- Check the filling level (10.) and keep on filling the bath liquid using the funnel until you get within the level marked "MAX".
- Close the filling funnel and move it to the back.
- Replace the venting grid.

5.7. Draining



Notice:

- Do not drain the bath fluid while it is hot or cold! Check the temperature of the bath fluid prior to draining (by switching the unit on for a short moment, for example).
- Store and dispose of the used bath fluid according to the environmental protection laws.

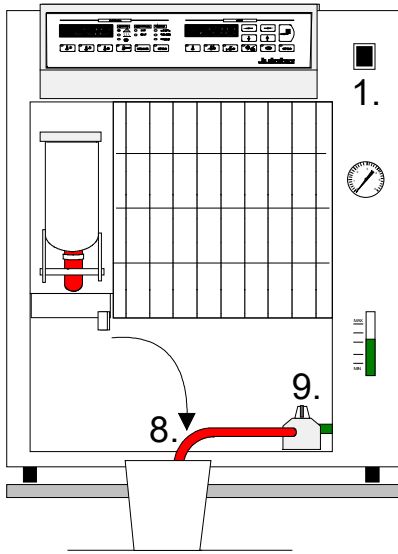

- Turn the mains switch (1.) off.
- Hold the venting grid, pull out and remove.
- Take the drain tubing (8.) out of the holder and hold it into a pail.
- Open the drain tap (9.) and empty the unit completely.
- Close the drain tap and replace the drain tubing into the holder.
- Replace the venting grid.

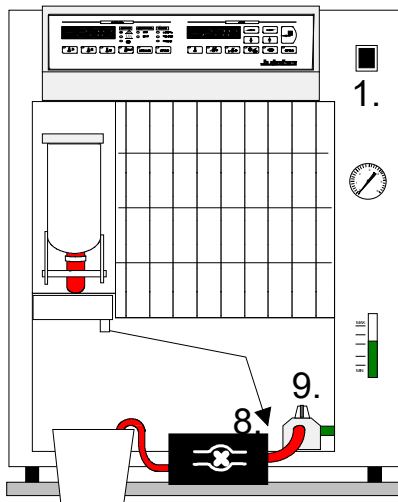

In case the recirculating cooler is placed on the floor, the unit may be drained using a suction pump unit.

- Connect the drain tubing (8.) to the suction pump unit.
- Open the drain tap (9.).
- Switch the pump on and fully empty the unit.

6. Manual operation

6.1. Switching on

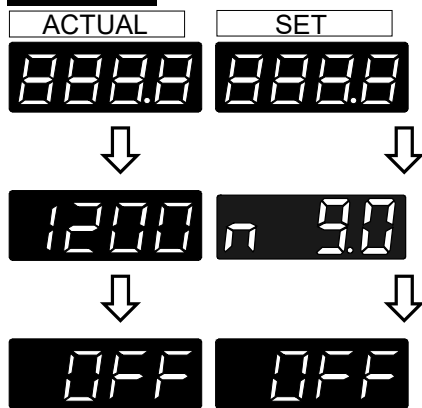
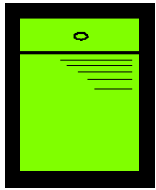

Turn on the mains power switch (1.).
An illuminated switch indicates the unit is on.

The unit performs a self-test. All segments of the 4-digit MULTI-DISPLAY (LED 1 + LED 2) and all indicator lights will illuminate.

Then the model designation and software version appear on the MULTI-DISPLAY for about 3 seconds (Example: FC"1200", "n 9.0").

The display "OFF" indicates the recirculating cooler is ready to operate (rOFF - see page 31).

6.2. Start



- Press the Enter key (5.4) for about 2 seconds.

The MULTI-DISPLAY (LED 1) indicates the actual feed temperature (example: 20.3 °C).

The MULTI-DISPLAY (LED 2) indicates the setpoint for the bath temperature (example: -5.0 °C).

Actual value Setpoint

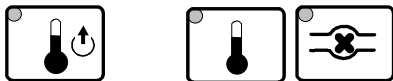

The indicator lights signal the actual operating mode.

- | | |
|--------------------|-------------------------------|
| - Display | Feed temperature (A) |
| - Display | Setpoint bath temperature (E) |
| - Circulating pump | On (J) |
| - Status | Cooling on ❄ |
| - Control | Internal temperature control |
| - Mode | Keypad control mode |

6.2.1. Automatic / non-automatic start mode

NOTE:

The recirculating cooler has been configured and supplied by JULABO according to N.A.M.U.R. recommendations. This means for the start mode, that the unit must enter a safe operating state after a power failure (non-automatic start mode). This safe operating state is indicated by „OFF“ or „rOFF“, resp. on the MULTI-DISPLAY (LED). A complete shutdown of the main functional elements such as heater and circulation pump is effected simultaneously. Should such a safety standard not be required, the AUTOSTART function (automatic start mode) may be activated, thus allowing the start of the recirculating cooler directly by pressing the mains power switch or using a timer.

Activating/deactivating AUTOSTART

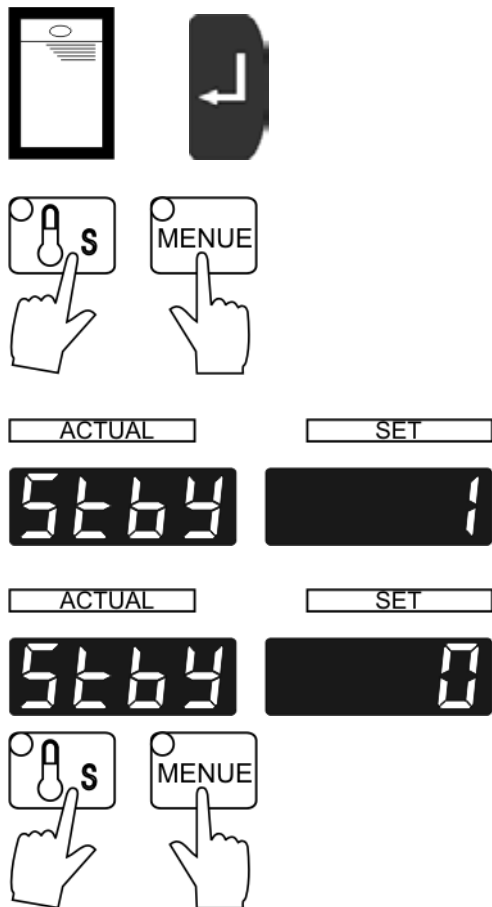

1. Turn on the recirculating cooler with the mains power switch and press the Enter key to start operation.
2. **Simultaneously** press the safety temperature key (C) and the MENU key (4.2) to enter the setting mode. Press the edit key  to select the parameter on the MULTI-DISPLAY (LED2). „1“ - AUTOSTART off. „0“ - AUTOSTART on.

Press the Enter key  to store the parameter.

3. **Simultaneously** press the safety temperature key (C) and the MENU key (4.2) to exit the setting mode.

The AUTOSTART function (automatic start mode) allows the start of the recirculating cooler directly by pressing the mains power switch or using a timer.



Warning:

For supervised or unsupervised operation with the AUTOSTART function, avoid any hazardous situation to persons or property. The recirculating cooler does no longer conform to N.A.M.U.R. recommendations.

Take care you fully observe the safety and warning functions of the recirculating cooler.

6.3. Setting the setpoint temperatures

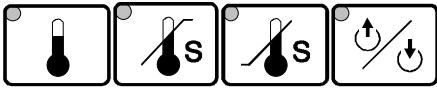

Set the setpoints before or after starting the unit.

Press the setpoint keys (E, F, G, H) to set a value and press the Enter key to store the value.

The values will stay in memory when the recirculating cooler is powered down.

6.3.1. Setting the temperature

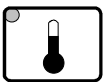

Example: Setting the bath temperature

- 1 Press the setpoint key . The indicator light **blinks** and the value previously set appears on the MULTI-DISPLAY (LED) (example: -10.8 °C)..

- 2 Use the cursor keys to move left or right on the display until the numeral you wish to change is blinking.

- 3 Use the increase/decrease arrows to change the selected numeral (-, 0, 1, 2, 3, ... 9).



- 4 Press enter to store the selected value (example: -8.0 °C).

6.3.2. Setting the control ratio for feed/return flow temperature

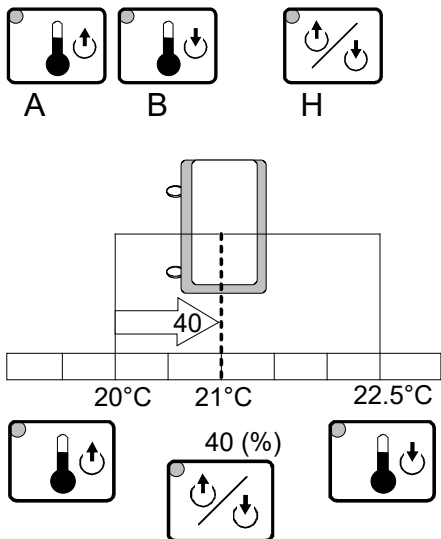
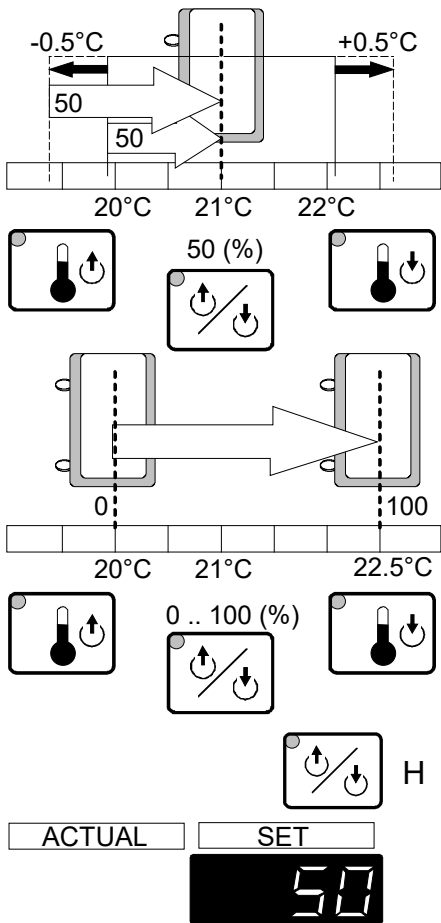

In respect to the values for feed and return temperature and the factor set with the key "H" an almost constant temperature value may be maintained in the external system. The control function quickly responds to changing conditions (ambient temperature, reaction heat), and thus spares the use of an external sensor.

The control ratio for feed and return flow temperature is factory preset to "50:50".

For enabling optimum control performance for asymmetric experiments, this ratio may be adjusted from 0 to 100 %.

- 0 % control with full respect to feed temperature
- 100 % control with full respect to return temperature.

Setting:

- 1 Press the key 

Follow the instructions under section 6.3.1. page 23

- 2
- 3
- 4

Calculation example:

Look up the values for control ratio, actual feed and return temperatures on the display by pressing the keys (A, B, H).

Example: $\vartheta_{RETURN} = 22.5\text{ }^{\circ}\text{C}$
 $\vartheta_{FEED} = 20\text{ }^{\circ}\text{C}$
 factor = 40 %

Formula for calculating the actual value:

$$\vartheta_{ACT} = \vartheta_{RETURN} * \frac{factor}{100} + \vartheta_{FEED} * \frac{(100 - factor)}{100}$$

$$\vartheta_{ACT} = 22.5^{\circ}\text{C} \frac{40}{100} + 20^{\circ}\text{C} \frac{(100 - 40)}{100}$$

$$\vartheta_{ACT} = 21^{\circ}\text{C}$$

6.3.3. Setting the safety temperatures

This safety function is **independent** of the control circuit.

- 1 Press the desired setpoint key (F, G).
Follow the instructions under section 6.3.1.
page 23

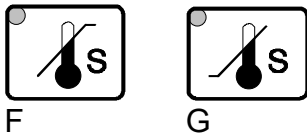

- 2
- 3
- 4



Recommendation:

Set the high temperature limit at least 5 K above the actual bath temperature.

Set the low temperature limit at least 5 K below the setpoint.

When the temperature of the bath liquid reaches the limits of the safety values, a complete shutdown of the circulating pump, heater and cooling compressor is effected.

The alarm light illuminates and an audible signal is triggered. An error message appears on the MULTI-DISPLAY (LED 2)

(see page 28).

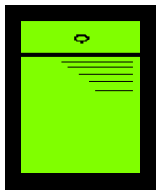
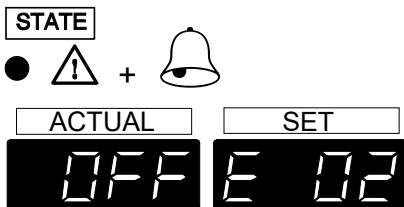

Turn the mains switch (1.) off and on. The alarm state is cancelled and the circulator is put back into operation. (Switching on - see page 21).

6.3.4. Low liquid level protection

As soon as the bath liquid falls below the "MIN" level (10.), a complete shutdown of the circulating pump, heater, and cooling compressor is effected.

The alarm light illuminates and an audible signal is triggered. An error message appears on the MULTI-DISPLAY (LED 2)

(see page 28).

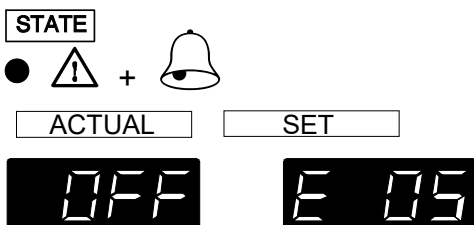

6.4. PID control parameters

CONTROL

- INT
- EXT

For internal and external control two separate parameter sets are available.

The PID control parameters can be adapted to the requirements of the controlled member.

The values are preserved after switching off the recirculating cooler.

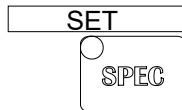

- The control parameters are indicated by operating the key  (5.1).









Indications in case of internal control  INT:

Parameter		Setting range
CP 1	Xp (example 4.0 K).	0.1 ... 100 K
CP 2	Tn (example 160 s).	1 ... 9999 s
CP 3	Tv (example 20 s).	0 ... 500 s

Each indicated control parameter can be optimized manually .

Setting:



- 1 Operate the key  as often until the desired control parameter is indicated. Example: CP3
- 2 Use the cursor keys   to move left or right on the display until the numeral you wish to change is blinking.
- 3 Use the increase/decrease arrows   to change the selected numeral (-, 0, 1, 2, 3, ... 9).
- 4 Press enter  to store the selected value

Optimization instructions for the PID control parameters:

The heat-up curve reveals inappropriate control settings

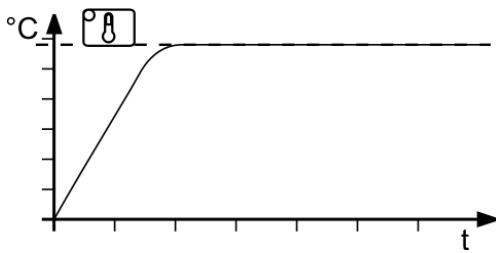

optimum setting

Inappropriate settings may produce the following heat-up curves:

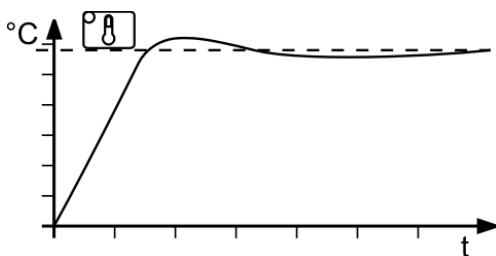

X_p too low

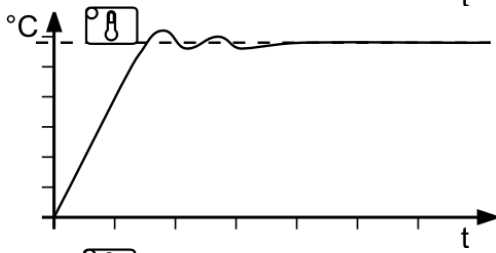

T_v/T_n too low

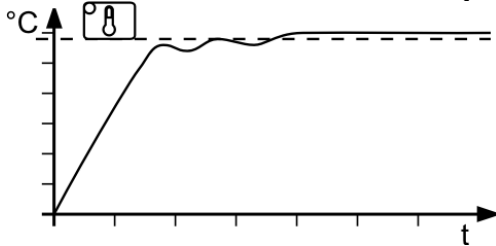

X_p
or
 T_v too high

7. Trouble shooting guide

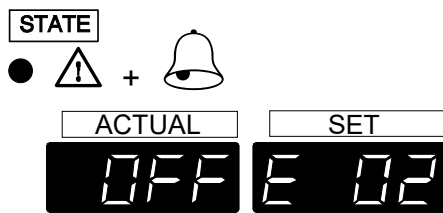

Whenever the microprocessor electronics registers a failure, an alarm is triggered and a **complete shutdown** is performed.

The alarm light illuminates and an audible signal is triggered. An error message appears on the MULTI-DISPLAY (LED 2).



Internal error



High temperature alarm



Low temperature alarm



The values reported by the safety sensor and the sensor in the feed connector differ by more than 25 K (defective sensor).



Low liquid level alarm



} Internal errors



Pump disconnection



Compressor disconnection



Heater disconnection

Turn the unit off with the mains switch (1), and eliminate the malfunction. If the unit cannot be returned to operation, contact an authorized service station.

7.1. Other error messages

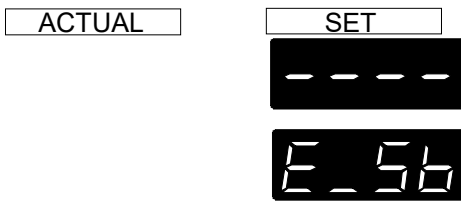

Incorrect/invalid entry. Value too small or too large, or function not available.

Under menu item E_Sb the parameter is set to 1, and the connection between Pin 2 and Pin 3 of the stand-by connector is interrupted (see page 29).

8. Electrical connections



Notice: Use shielded cables only.
The shield of the connecting cable is electrically connected to the plug housing.

Stand-by input (L)

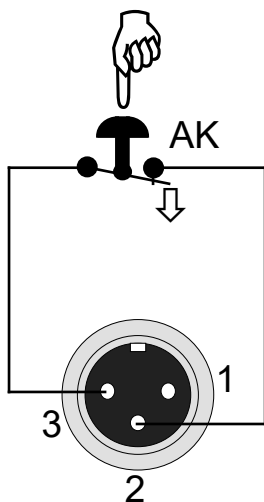

Pin assignment:	Pin	Signal
	1	not used
	2	5 V / DC
	3	0 V

Activate the stand-by input:

Under menu item E_Sb, set the parameter to 1 (see page 35).

Connect an external contact 'AK' (e.g. for emergency switch-off) or an alarm contact of the superordinated application system. In case the connection between Pin 2 and Pin 3 is interrupted by opening the contact 'AK', a complete shutdown of the circulating pump, heater and cooling compressor is effected, and the unit enters the condition "stand-by". The message "E_Sb" appears on the MULTI-Display (LED2) (see page 29).

Alarm output (M)

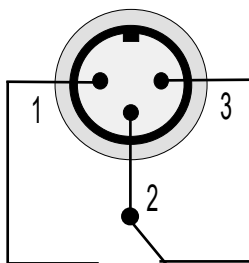

This potential-free change-over contact is activated in case of an alarm.

Pins 2 and 3 are connected under the following conditions:

- alarm
- status "OFF" and "rOFF"
- mains switch "off"

Switching capacity max. 30 W / 40 VA

Switching voltage max. 125 V~/–

Switching current max. 1 A

Serial interface (K)

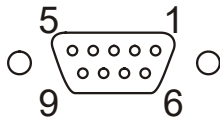

This interface is a 9-pole connector:

Pin 2	RxD	Receive Data
Pin 3	TxD	Transmit Data
Pin 5		Gnd
Pin 7	RTS	Request to send
Pin 8	CTS	Clear to send

Interface correspondence:

Circulator		Computer		Circulator		Computer
9-pole		25-pole		9-pole		9-pole
Pin 2 RxD	↔	Pin 2 TxD		Pin 2 RxD	↔	Pin 3 TxD
Pin 3 TxD	↔	Pin 3 RxD		Pin 3 TxD	↔	Pin 2 RxD
Pin 5 GND	↔	Pin 7 GND		Pin 5 GND	↔	Pin 5 GND
Pin 7 RTS	↔	Pin 5 CTS		Pin 7 RTS	↔	Pin 8 CTS
Pin 8 CTS	↔	Pin 4 RTS		Pin 8 CTS	↔	Pin 7 RTS

Accessories:

Order No.	Description
8 980 073	RS232 interface cable 9-pol./9-pol. , 2,5 m
8 900 110	USB interface adapter cable

Return flow safety device

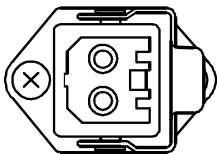

Control connector for solenoid valves (14.)
(line voltage: 230 V).

9. Remote control

9.1. Communication with a PC or data system



For remote control, under the menu item **OP** (Operating mode) set the parameter to 1.

The message "rOFF" appears on the display.

In general, the computer (master) sends commands to the recirculating cooler (slave). The recirculating cooler sends data (including error messages) only when the computer asks for it.

A transfer sequence consists of:

- command
- space (↔; Hex: 20)
- parameter (the character separating
- decimals in a group is the period)
- end of file (↵; Hex: 0D)

The commands are divided into **in** or **out** commands.

in commands: asking for parameters to be displayed

out commands: setting parameters



The **out** commands are valid only in remote control mode.

Examples:

- Command to set the setpoint to 5.5 °C:
out_sp_00 ↔ 5.5↵
- Command to ask for the setpoint:
in_sp_00↵
- Response from the recirculating cooler:
↵

9.2. List of commands

Command	Parameter	Response of recirculating cooler
version	no	Number of software version
status	no	Status message (see below)
out_mode_04	0	Set control mode via PC
out_mode_04	1	Set control mode via programmer input (O)
in_mode_04	no	Ask for actual control mode
out_mode_05	0	Stop the recirculating cooler = rOFF
out_mode_05	1	Start the recirculating cooler
in_mode_05	no	Ask for actual condition (Start/Stop)
out_sp_00	xx.x	Set working temperature value
in_sp_00	no	Ask for working temperature value
in_sp_01	no	Ask for high temperature value
in_sp_02	no	Ask for low temperature value
out_sp_03	xxx	Set control ratio for feed/return flow temperature
in_sp_03	no	Ask for actual control ratio
in_pv_00	no	Ask for actual feed temperature
in_pv_01	no	Ask for actual temperature of external sensor
in_pv_02	no	Ask for actual heater capacity
in_pv_03	no	Ask for actual return temperature
in_pv_04	no	Ask for actual safety temperature
out_par_06	x.x	Control parameter Xp of the internal controller
in_par_06	x.x	out = set; in = ask
out_par_07	xx.xx	Control parameter Tn of the internal controller
in_par_07	xx.xx	out = set; in = ask
out_par_08	xx.xx	Control parameter Tv of the internal controller
in_par_08	xx.xx	out = set; in = ask

9.3. Status messages

Message	Description - Recirculating cooler ...
00 MANUAL STOP	... in condition "OFF" (LOCAL)
01 MANUAL START	... in keypad control mode (LOCAL)
02 REMOTE STOP	... in condition "rOFF" (RS 232)
04 REMOTE START	... in remote control mode (RS 232)

9.4. Error messages

Message	Description
-01 WORKING PROCESSOR ALARM	Internal error
-02 EXCESS TEMPERATURE ALARM	High temperature alarm
-03 LOW TEMPERATURE ALARM	Low temperature alarm
-04 SENSOR DIFFERENCE ALARM	Sensor difference alarm $ \vartheta_{\text{Safety sensor}} - \vartheta_{\text{Feed}} > 25^{\circ}\text{C}$
-05 LOW LEVEL ALARM	Low liquid level alarm
-06 PROCESSOR COMMUNICATION ERROR	Internal error
-07 I2C-BUS WRITE ERROR	Internal error
-08 I2C-BUS READ ERROR	Internal error
-09 I2C-BUS READ/WRITE ERROR	Internal error
-10 COMMAND NOT ALLOWED IN CURRENT OPERATING MODE	Invalid command in current operating mode
-12 VALUE TOO SMALL	Value too small
-13 VALUE TOO LARGE	Value too large
-14 INVALID COMMAND	Invalid command
-15 WARNING: STAND-BY PLUG IS MISSING	External stand-by plug is missing (see page 29)
-16 WARNING: VALUE EXCEEDS TEMPERATURE LIMITS	Value lies outside the permissible range for the safety temperature limits. But value is stored anyway.
-17 PUMP ERROR	Pump disconnection
-18 COMPRESSOR ERROR	Compressor disconnection
-19 HEATER TRIAC SHORTED	Heater disconnection

10. Menu functions

Set the parameters for the recirculating cooler via the configuration or calibration level.

10.1. Selecting/exiting the configuration level

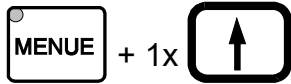
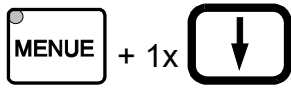

Simultaneously press the "MENUE" key (4.2) and the edit key "↓" to select the configuration level or the edit key "↑" to exit the configuration level.

Select the menu items of the configuration level one by one by pressing simultaneously the menu key and one of the cursors.

10.2. Setting the parameters

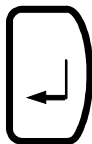
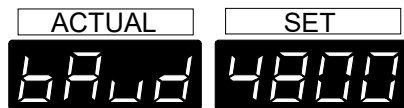
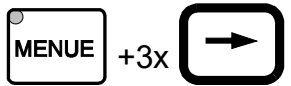
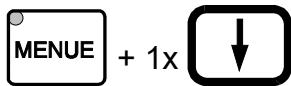

Example: Baud rate

- ① Select the configuration level by pressing the keys simultaneously.
- ② Select the menu item by pressing simultaneously the menu key and one of the cursors. (example: press the cursor key "→" 3 times).
- ③ Set the baud rate (4800 Bauds) with the edit keys ("↑" or "↓").
- ④ Press the enter key to store the new parameter.

10.3. Adjustable parameters

Set the parameters for the following menu items in the configuration level:

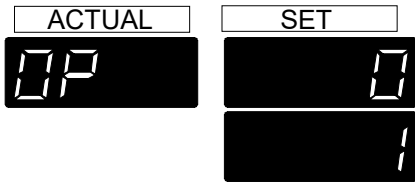

OP - Operating mode

- 0 = Keypad control
- 1 = Remote control via RS 232

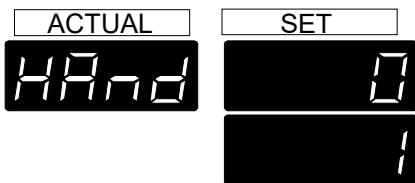

HAnd - Handshake of the serial interface

- 0 = XOn/XOff, software handshake
- 1 = RTS/CTS, hardware handshake *

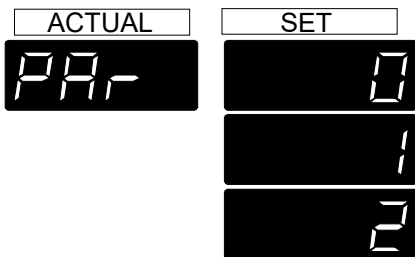

PAr - Parity bits of the serial interface

- 0 = no
- 1 = odd
- 2 = even *

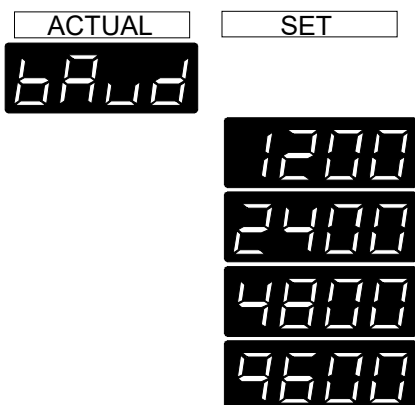

bAud - Baud rate of the serial interface

- 1200 Bauds
- 2400 Bauds
- 4800 Bauds*
- 9600 Bauds

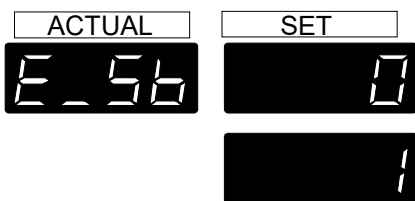

E_Sb - External stand-by for emergency switch-off

- 0 = stand-by input is ignored *
- 1 = stand-by input is active
(Stand-by input - see page 29)

(* factory setting)

11. Cleaning / repairing the unit



Caution:

Always turn off the unit and disconnect the mains cable from the power source before cleaning the unit.

Prevent humidity from entering into the circulator.

Service and repair work may be performed only by authorized electricians.

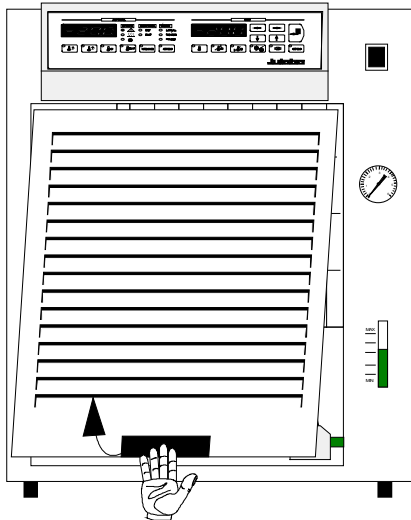

In order to maintain a good condition of the cooling compressor, the condenser should be checked for contamination in regular intervals.

- Switch the unit off, disconnect the power plug.
- Hold the venting grid, pull out and remove.
- Remove the dirt from the condenser with a vacuum cleaner.
- Replace the venting grid.

The unit is ready to operate again.

Cleaning:

Clean the outside of the unit using a wet cloth and low surface tension water.

The recirculating cooler is designed for continuous operation under normal conditions. Periodic maintenance is not required.

The tank should be filled only with a bath fluid recommended by JULABO. To avoid contamination, it is essential to change the bath fluid from time to time.

Repairs:

Before asking for a service technician or returning a JULABO instrument for repair, please contact an authorized JULABO service station.

JULABO Technical Service

Tel.: +1(610) 231-0250 Option 3

Fax: +1(610) 231-260

Email: Service@julabo.us

When returning the unit:

- Clean the unit in order to avoid any harm to the service personnel
- Attach a short fault description.
- When returning a unit, take care of careful and adequate packing.
- JULABO is not responsible for damages that might occur from insufficient packing.

12. WARRANTY PROVISIONS

The following Warranty Provisions shall apply to products sold in North America by Julabo ("Seller") to the entity shown as buyer ("Buyer") on Seller's invoice.

Initial Warranty

Upon Seller's receipt of payment in full for the products and subject to Buyer's compliance with the terms of sale and any other agreement with Seller relating to the products, Seller warrants to the Buyer that the products manufactured by the Seller are free from defects in material and workmanship for a period not to exceed two (2) years of operation from the date the product is shipped by Seller to Buyer (the "Initial Warranty").

EXCLUSION OF ALL OTHER EXPRESS WARRANTIES; EXCLUSION OF ALL IMPLIED WARRANTIES.

OTHER THAN THE INITIAL WARRANTY, NO OTHER EXPRESS WARRANTIES ARE MADE. ALL IMPLIED WARRANTIES OF EVERY TYPE AND KIND, INCLUDING BUT NOT LIMITED TO ANY IMPLIED WARRANTY OF MERCHANTABILITY OR FITNESS FOR A PARTICULAR PURPOSE OR USE, ARE EXCLUDED IN ALL RESPECTS AND FOR ALL PURPOSES. SELLER DISCLAIMS AND MAKES NO IMPLIED WARRANTIES WHATSOEVER.

Exclusions

The Initial Warranty does not include damage to the product resulting from accident, misuse, improper installation or operation, unauthorized or improper repair, replacement or alteration (including but not limited to repairs, replacements, or alterations made or performed by persons other than Seller's employees or authorized representatives), failure to provide (or use of improper) maintenance, unreasonable or unintended use or abuse of the product, or failure to follow written installation or operating instructions.

Buyer must return the product's record of purchase to the Seller or one of Seller's authorized representatives within thirty (30) days of the date the product is shipped by Seller to Buyer in order to make a claim under the Initial Warranty. Notwithstanding anything contained herein to the contrary, all glassware, including but not limited to reference thermometers, are expressly excluded from the Initial Warranty.

Buyer's sole remedies; Limitations on Seller's Liability

Buyer's sole and exclusive remedy under the Initial Warranty is strictly limited, in Seller's sole discretion, to either: (i) repairing defective parts; or (ii) replacing defective parts. In either case, the warranty period for the product receiving a repaired or replaced part pursuant to the terms of the Initial Warranty shall not be extended. All repairs or replacements performed by Seller pursuant to these Warranty Provisions shall be performed at one of the Seller's facility in Allentown, Pennsylvania, U.S.A. or at the facility of an authorized representative of Seller, which location shall be determined by Seller in its sole discretion; provided, however, that Seller may, in its sole discretion perform such repairs or replacements at Buyer's facility in which case Buyer shall pay Seller's travel, living and related expenses incurred by Seller in performing the repairs or replacements at Buyer's facility. As a condition precedent to Seller's obligation to repair or replace a product part under the Initial Warranty, Buyer shall (i) promptly notify Seller in writing of any such defect; (ii) shall have returned the product's record of purchase to Seller or to Seller's authorized representatives within thirty (30) days of the date the product is shipped by the seller; and (iii) assist Seller in all respects in its attempts to determine the legitimacy and basis of any claims made by or on behalf of Buyer including but not limited to providing Seller with access to the product to check operating conditions. If Buyer does not provide such written notice to Seller within the Initial Warranty period or fails to return the product's record of purchase as set forth above, Seller shall have no further liability or obligation to Buyer therefor. In no event shall Seller's liability under the Initial Warranty exceed the original purchase price of the product which is the subject of the alleged defect.

THE REMEDIES PROVIDED IN THE INITIAL WARRANTY ARE THE SOLE AND EXCLUSIVE REMEDIES AVAILABLE TO THE BUYER. NOTWITHSTANDING ANYTHING TO THE CONTRARY CONTAINED HEREIN, AND EVEN IF THE SOLE AND EXCLUSIVE REMEDIES FAIL OF THEIR ESSENTIAL PURPOSE FOR ANY

WARRANTY PROVISIONS

REASON WHATSOEVER, IN NO EVENT SHALL SELLER BE LIABLE FOR BUYER'S MANUFACTURING COSTS, LOST PROFITS, GOODWILL, OR ANY OTHER SPECIAL, INDIRECT, PUNITIVE, INCIDENTAL OR CONSEQUENTIAL DAMAGES TO BUYER OR ANY THIRD PARTY AND ALL SUCH DAMAGES ARE HEREBY DISCLAIMED.

Assignment

Buyer shall not assign any of its rights or obligations hereunder without the prior written approval of Seller; provided, however, that if Buyer is a distributor of Seller, the rights and obligations of Buyer under these Warranty Provisions shall inure to the benefit of and be binding upon Buyer's customers who provide the product's proof of purchase to Seller pursuant to the terms set forth herein. Seller may assign any or all of its rights or obligations hereunder without Buyer's prior consent.

Governing Law

The Warranty Provisions and all questions relating to their validity, interpretation, performance, and enforcement shall be construed in accordance with, and shall be governed by, the substantive laws of the Commonwealth of Pennsylvania without regard to its principles of conflicts of law.

Waiver

Any failure of the part of Seller to insist on strict compliance with the Warranty Provisions shall no way constitute a waiver of such right. No claim or rights arising out of a breach of the Warranty Provisions by Buyer may be discharged in whole or in part by a waiver of the claim or right, unless the waiver is in writing signed by an authorized representative of Seller. Seller's waiver or acceptance of any breach by Buyer of any provisions of the Warranty Provisions shall not constitute a waiver of or an excuse for nonperformance as to any other provision of the Warranty Provisions nor as to any prior or subsequent breach of the same provision.

Freight

Seller will arrange and pay for shipping and handling for the return of the unit to the Buyer.

Out of Box Failure (OBF)

An Out of Box Failure (OBF) is defined as a product failure immediately following unpacking and installation of a newly delivered product. JULABO provides a 14-day grace period after the date of shipment, during which time the delivered product must be checked for defect. The same exclusions that apply to the regular warranty also apply to OBF classification. For example, JULABO will not be liable for transport damage, damage inflicted by the customer or any other party, or defects arising from improper installation or usage.